

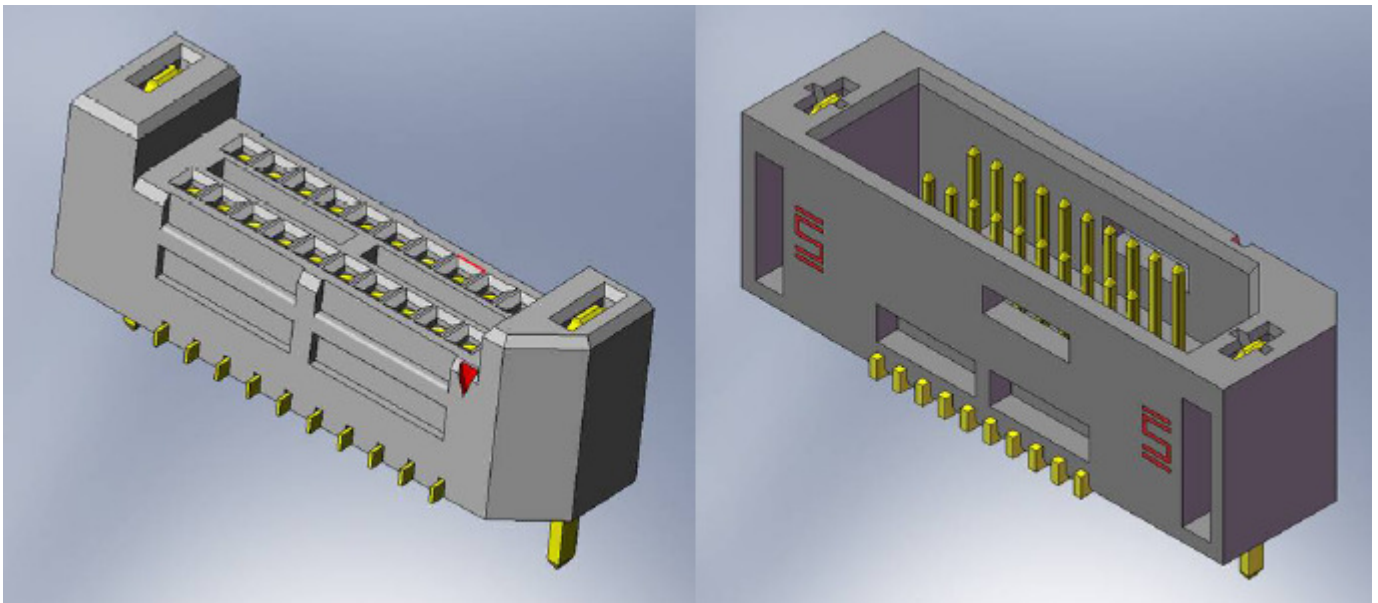

Project Number: 277286	Tracking Code: 277286_Power Test Report_Rev_1 .doc
Requested by: Catie Eichhorn	Date: 12/13/2013
Part #: SEM-125-02-03.0-G-D-WT/TEM-125-02-03.0-G-D-A	
Part description: SEM/TEM	Technician: Peter Chen
Test Start: 10/20/2013	Test Completed: 11/16/2013



SAMTEC POWER CHARACTERIZATION

PART DESCRIPTION

SEM-125-02-03.0-G-D-WT/TEM-125-02-03.0-G-D-A

CERTIFICATION

All instruments and measuring equipment were calibrated to National Institute for Standards and Technology (NIST) traceable standards according to ISO 10012-1 and ANSI/NCSL 2540-1, as applicable.

All contents contained herein are the property of Samtec. No portion of this report, in part or in full shall be reproduced without prior written approval of Samtec.

SCOPE

1. Temperature Rise/Current Carrying Capacity
 - 1.1. To determine the amount of current the device under test (DUT) can safely carry over the operating temperature range of the DUT.
 - 1.2. Contact loading will also be addressed in this document which will determine how much current can be carried as the number of energized contacts is varied.
2. Current Cycling
 - 2.1. To determine the performance of the device under test (DUT) when subjected to the power-on/power-off cycling that heats and cools the DUT in normal everyday use.
 - 2.2. Contact loading will set to 100% throughout the test.

APPLICABLE DOCUMENTS

Standards: EIA Publication 364-70 Temperature Rise
EIA Publication 364-06 Contact Resistance
EIA Publication 364-55 Current Cycling
TLPM-032 Current Carrying Capacity
TLPM-084 Current Cycling
IEC 512-3 Electromechanical Components for Electronic Equipment: Basic Testing Procedures and Measuring Methods, Part 3: Current Carrying Capacity Tests

TEST SAMPLES AND PREPARATION

- 1) All materials shall be manufactured in accordance with the applicable product specification.
- 2) All test samples shall be identified and encoded to maintain traceability throughout the test sequences.
- 3) After soldering, the parts to be used shall be cleaned according to TLWI-0001.
- 4) All samples shall be visually inspected and cleaned as necessary.
- 5) Any additional preparation shall be noted in the individual test sequences.
- 6) Solder Information: Lead Free
- 7) Re-Flow Time/Temp: See accompanying profile.
- 8) All products designed to operate mounted on a printed circuits board shall be tested mounted to test boards in accordance with EIA-364-70.

PREPARED TEST SAMPLE

- 9) The following loading configurations shall be tested for Temperature Rise/Current Carrying Capacity testing of two row connector systems:
- a. Two by One contact energized
 - b. Two by Two contacts energized adjacent to each other
 - c. Two by Three contacts energized adjacent to each other
 - d. Two by Four contacts energized adjacent to each other
 - e. All contacts energized

Test Condition as in 10.1 above

✦ Indicates energized contacts

✦ Indicates thermocouple monitored, energized contacts
✦ Indicates thermocouple monitored, energized contacts

10) For Current Cycling, only 100 % loading will be tested.

✦			
✦			

OVEN PROFILE (Soldering Parts to Test Boards)

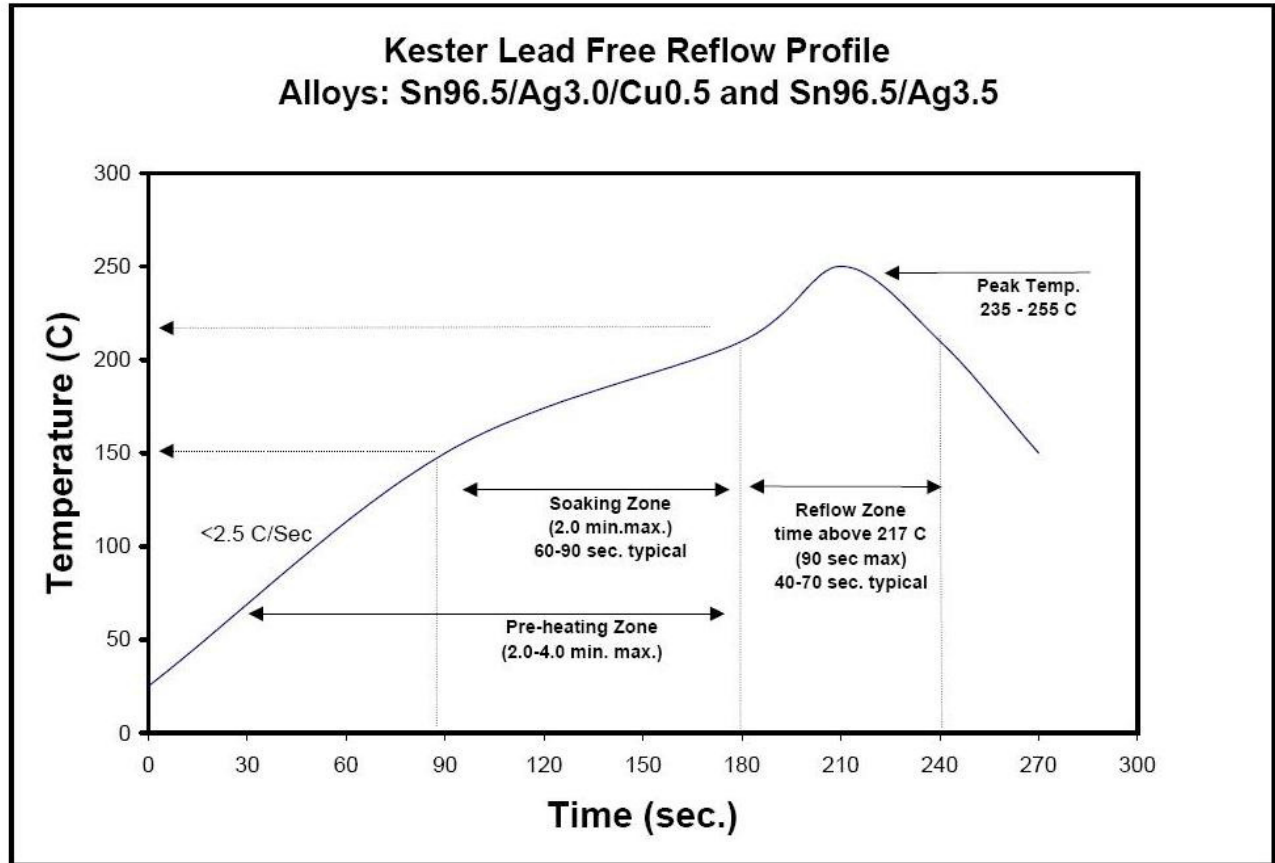



POWER INTEGRITY TEST REPORT

277286

INITIAL RELEASE

FLOWCHARTS

Current Carrying Capacity

Group 1
SEM-125-02-03.0-G-D-WT
TEM-125-02-03.0-G-D-A
2 Pins Powered
Signal

Step	Description
1.	CCC (1) Rows = 2 Number of Positions = 1

Group 2
SEM-125-02-03.0-G-D-WT
TEM-125-02-03.0-G-D-A
4 Pins Powered
Signal

Step	Description
1.	CCC (1) Rows = 2 Number of Positions = 2

Group 3
SEM-125-02-03.0-G-D-WT
TEM-125-02-03.0-G-D-A
6 Pins Powered
Signal

Step	Description
1.	CCC (1) Rows = 2 Number of Positions = 3

Group 4
SEM-125-02-03.0-G-D-WT
TEM-125-02-03.0-G-D-A
8 Pins Powered
Signal

Step	Description
1.	CCC (1) Rows = 2 Number of Positions = 4

Group 5
SEM-125-02-03.0-G-D-WT
TEM-125-02-03.0-G-D-A
50 Pins Powered
Signal

Step	Description
1.	CCC (1) Rows = 2 Number of Positions = 25

(1) CCC = EIA-364-70
Method 2, Temperature Rise Versus Current Curve
(TIN PLATING) - Tabulate calculated current at RT, 65°C, 75°C and 95°C after derating 20% and based on 105°C
(GOLD PLATING) - Tabulate calculated current at RT, 85°C, 95°C and 115°C after derating 20% and based on 125°C

Current Cycling

Group 1
SEM-125-02-03.0-G-D-WT
TEM-125-02-03.0-G-D-A
8 Assemblies

Step	Description
1.	Current Cycle (1)

(1) Current Cycle = EIA 364-55
Test Condition = B (125% Rated Current)
Method = 4 (On: 45 Minutes, Off: 15 Minutes)
Number of Cycles = 500



POWER INTEGRITY TEST REPORT

277286

INITIAL RELEASE

TEST PROCEDURES

Part No.	SEM-125-02-03.0-G-D-WT	Mating Part No.	TEM-125-02-03.0-G-D-A
Sample Size	9	Technician	Peter Chen
Start Date	11/12/2013	Complete Date	11/15/2013
Room Ambient	22°C	Relative Humidity	54%
Equipment ID#: HZ-MO-01, HZ-PS-01, HZ-TCS-001, HZ-TCS-003, HZ-TCS-005			

TEMPERATURE RISE (Current Carrying Capacity, CCC):

- 1) Thermocouples shall be calibrated in accordance with Samtec documents; TLWI 0003, Thermocouple Welding Procedure and TLWI 0005, Thermocouple Calibration
- 2) The thermocouples shall be placed at a location to sense the maximum temperature generated during testing.
- 3) Temperature stability shall be defined as the temperature at which three successive readings, 5 minutes apart, differ not more than 1° C (computer controlled data acquisition). This is the Temperature Rise that the Current Carrying Capacity and De-rating curves are based on.
- 4) The following loading configurations shall be tested (double for two row systems):
 - a. One contact energized only
 - b. Two contacts energized adjacent to each other
 - c. Three contacts energized adjacent to each other
 - d. Four contacts energized adjacent to each other
 - e. All contacts energized
- 5) The following loading configurations shall be tested for Temperature Rise/Current Carrying Capacity testing of two row connector systems:
 - a. Two by One contact energized
 - b. Two by Two contacts energized adjacent to each other
 - c. Two by Three contacts energized adjacent to each other
 - d. Two by Four contacts energized adjacent to each other
 - e. All contacts energized
- 6) Three samples shall be tested for each of the above configurations for a total of eighteen assemblies.
- 7) Temperature Rise measurements shall be made at 5 different current levels yielding temperature rises in the 10 to 70°C range.
- 8) The base curve for the Current Rating chart will be derived from the average (maximum) value of three test specimens in accordance with IEC 512-3, Test 5b.



**POWER INTEGRITY TEST
REPORT**

277286

INITIAL RELEASE

Part No.	SEM-125-02-03.0-G-D-WT	Mating Part No.	TEM-125-02-03.0-G-D-A
Sample Size	8	Technician	Peter Chen
Start Date	10/20/2013	Complete Date	11/16/2013
Room Ambient	23°C	Relative Humidity	49%
Equipment ID#: HZ-PS-03;HZ HZ-MO-06; HZ-TCS-015; HZ-TCS-020;HZ-TCS-028;HZ-TCS-041;HZ-TCS-007;HZ-TCS-003;HZ-TCS-004;HZ-TCS-013;HZ-TCS-035;;			

CURRENT CYCLING

1. Samples shall be prepared and tested as above (paragraph 14.5).
2. Current Cycling shall be performed in accordance with EIA-364-55, Test Condition
3. Testing shall be as follows:
 - 3.1. Test Current: 1.2 Amps (125% of 30°C Rating)
 - 3.2. "ON" Time: 45 Minutes
 - 3.3. "OFF" Time: 15 Minutes
 - 3.4. Number of Cycles: 500
 - 3.5. Measurements: 40 minutes into ON cycle
 - 3.5.1. Temperature
 - 3.5.2. Voltage Drop/Contact Resistance
4. Temperature vs. Number of Cycles and Voltage Drop vs. Number of Cycles shall be measured and recorded.



TEST RESULTS

CURRENT CARRYING CAPACITY (CCC) RESULTS

- There was no evidence of physical damage to the test samples as tested.
- The following is a summary of the observed data:

Temperature Rise, CCC at a 20% de-rating

- CCC for a 30°C Temperature Rise -----2.9 A per contact with 2 adjacent signal contacts powered
- CCC for a 30°C Temperature Rise -----2.2 A per contact with 4 adjacent signal contacts powered
- CCC for a 30°C Temperature Rise -----1.8 A per contact with 6 adjacent signal contacts powered
- CCC for a 30°C Temperature Rise -----1.6 A per contact with 8 adjacent signal contacts powered
- CCC for a 30°C Temperature Rise -----1.0 A per contact with all adjacent signal contacts powered

CURRENT CYCLING RESULTS

Test Condition: 500 Cycles, 45 minutes ON and 15 minutes OFF

- Test Current ----- 1.2 Amps
- Contact Resistances, Measured 40 minutes into the FIRST and LAST ON cycle
 - Initial
 - Min ----- 7.59 mOhms
 - Max-----13.28 mOhms
 - Final
 - Min ----- 7.49 mOhms
 - Max-----13.12 mOhms
- Temperature Change, Measured 40 minutes into the FIRST and LAST ON cycle
 - Initial Temperature Change -----28.6°C
 - Final Temperature Change -----27.9°C

TEST DATA

CONTACT RESISTANCE @ RATED CURRENT - DC Resistance (DCR)

The following data represents the Voltage drop and Contact Resistance at Rated Current for the 100% energized samples:

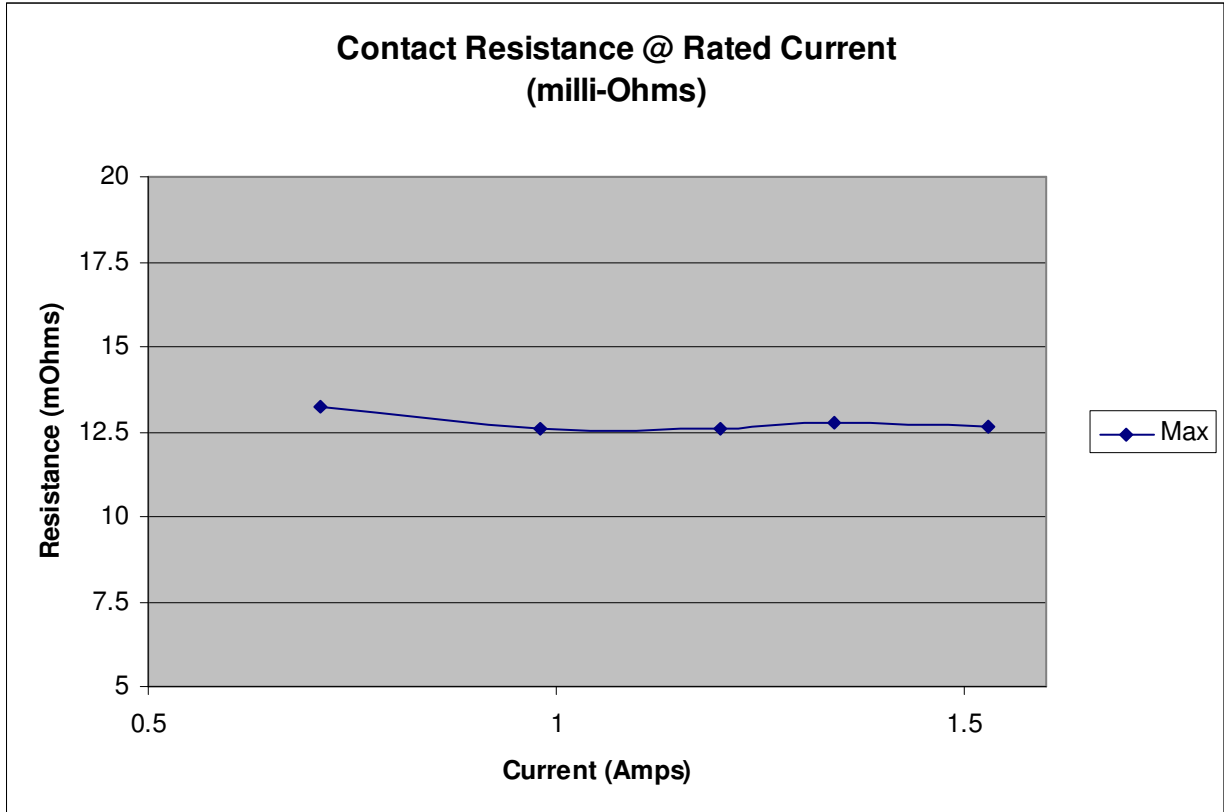

**CONTACT RESISTANCE DATA
ALL CONTACTS ENERGIZED
(mΩ)**

TEST CURRENT AMPS	0.71	0.98	1.2	1.34	1.53
Min	7.8	7.88	7.93	8.05	8.09
Max	13.25	12.61	12.59	12.74	12.63
Avg	10.34	10.82	10.75	10.82	10.75

TEST DATA

VOLTAGE DROP @ RATED CURRENT

The following data represents the Voltage drop at Rated Current for the 100% energized samples:

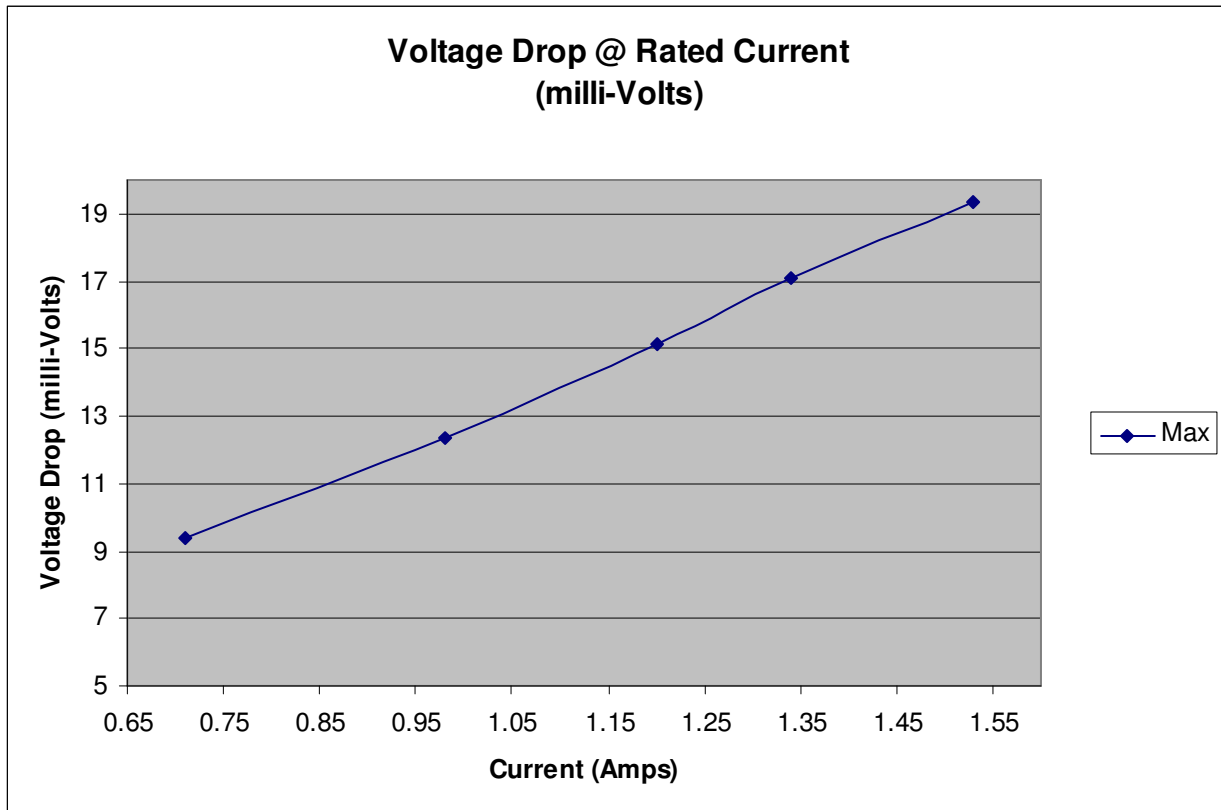

**VOLTAGE DROP DATA
ALL CONTACTS ENERGIZED
(mV)**

TEST CURRENT AMPS	0.71	0.98	1.2	1.34	1.53
Min	5.54	7.72	9.51	10.79	12.38
Max	9.41	12.36	15.11	17.07	19.33
Avg	7.05	10.05	12.28	13.86	15.74

CURRENT CARRYING CAPACITY DATA

277286
2 (2x1) Signal Pins Powered in Series
Part Numbers: TEM-125-02-DH1-S-D / SEM-125-03.0-S-D-WT

Current Rating per Contact (30 Deg. Rise, 20% Derated) = 2.9 Amps

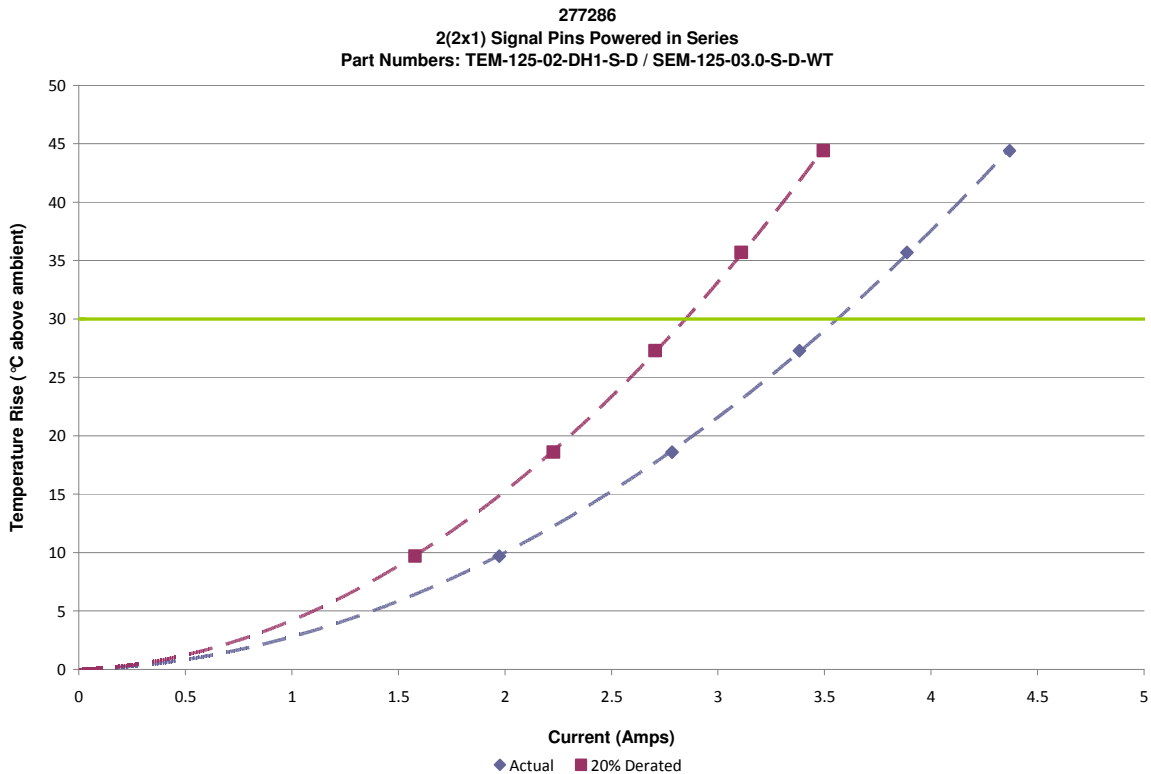
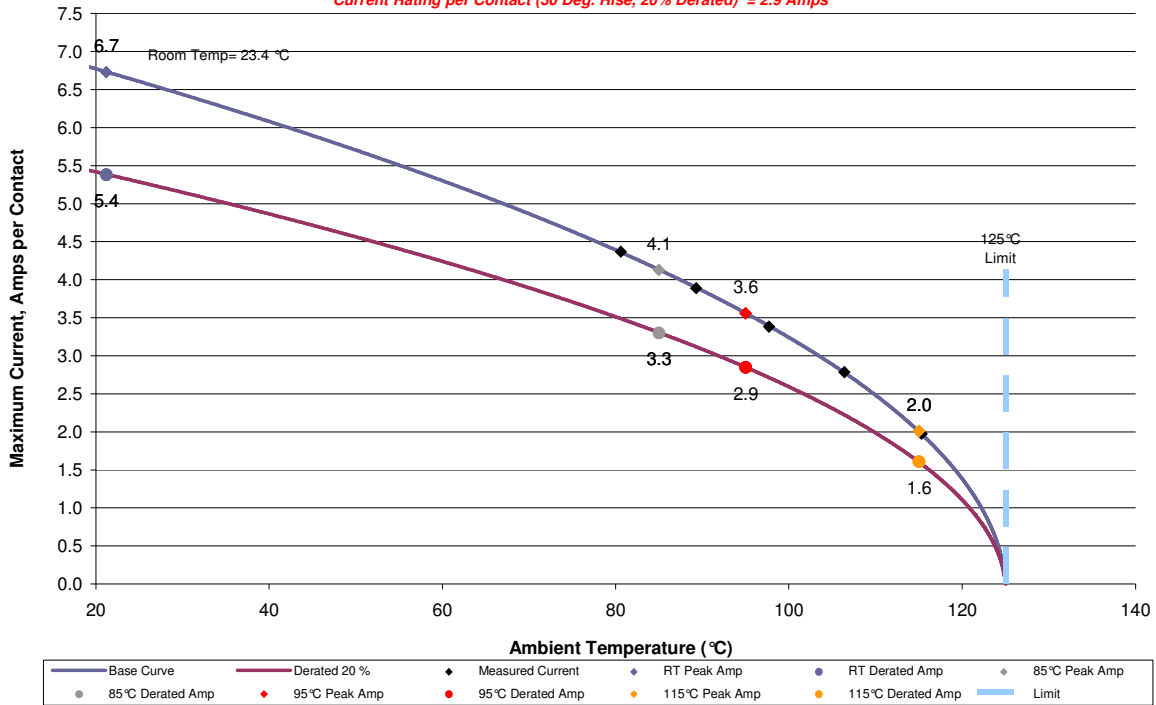



POWER INTEGRITY TEST REPORT

277286

INITIAL RELEASE

TEMPERATURE RISE DATA TWO CONTACT ENERGIZED (Degrees Celsius above ambient)

TEST CURRENT AMPS	1.97	2.79	3.38	3.89	4.37
Sample 1	9.7	18.4	27	35.4	44
Sample 2	9.6	18.5	26.8	34.8	43.3
Sample 3	9.7	18.9	28	36.8	45.9
Min	9.6	18.4	26.8	34.8	43.3
Max	9.7	18.9	28	36.8	45.9
Avg	9.67	18.6	27.27	35.67	44.4

Double Row Configuration

- ✦ Indicates energized contacts
- ✦ Indicates thermocouple monitored, energized contacts

✦			
✦			

277286

4 (2x2) Signal Pins Powered in Series

Part Numbers: TEM-125-02-DH1-S-D / SEM-125-03.0-S-D-WT

Current Rating per Contact (30 Deg. Rise, 20% Derated) = 2.2 Amps

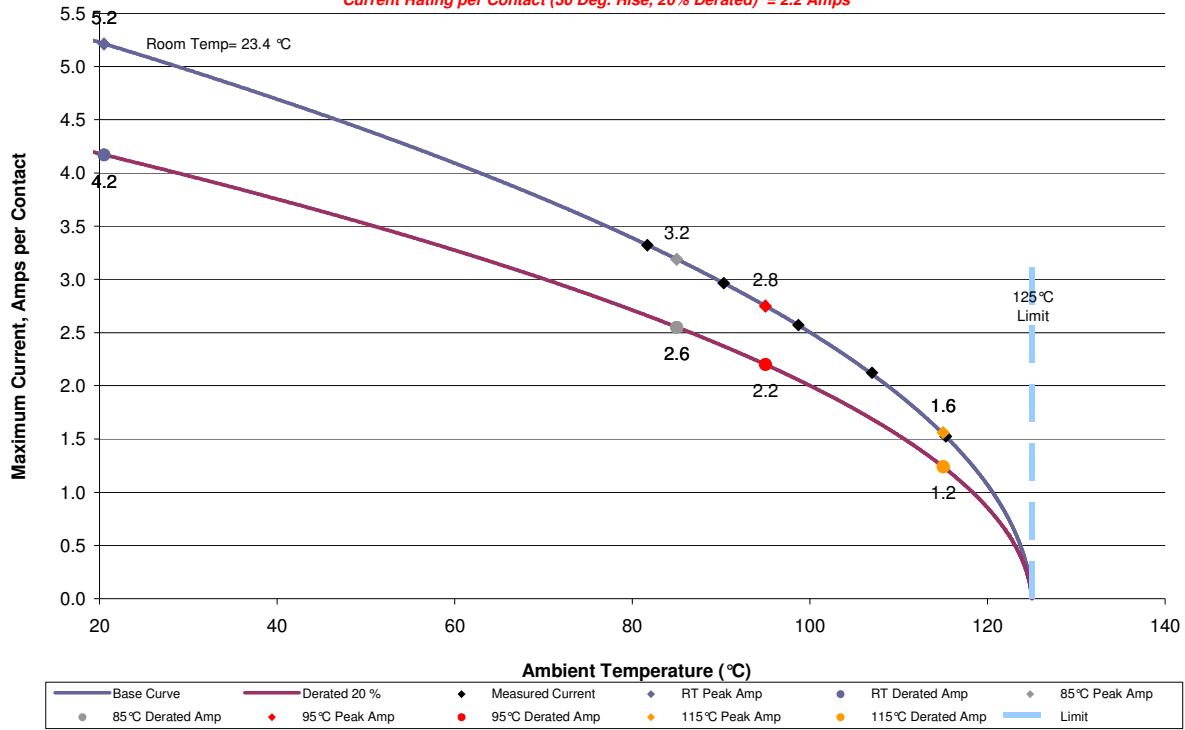

277286

4(2x2) Signal Pins Powered in Series

Part Numbers: TEM-125-02-DH1-S-D / SEM-125-03.0-S-D-WT

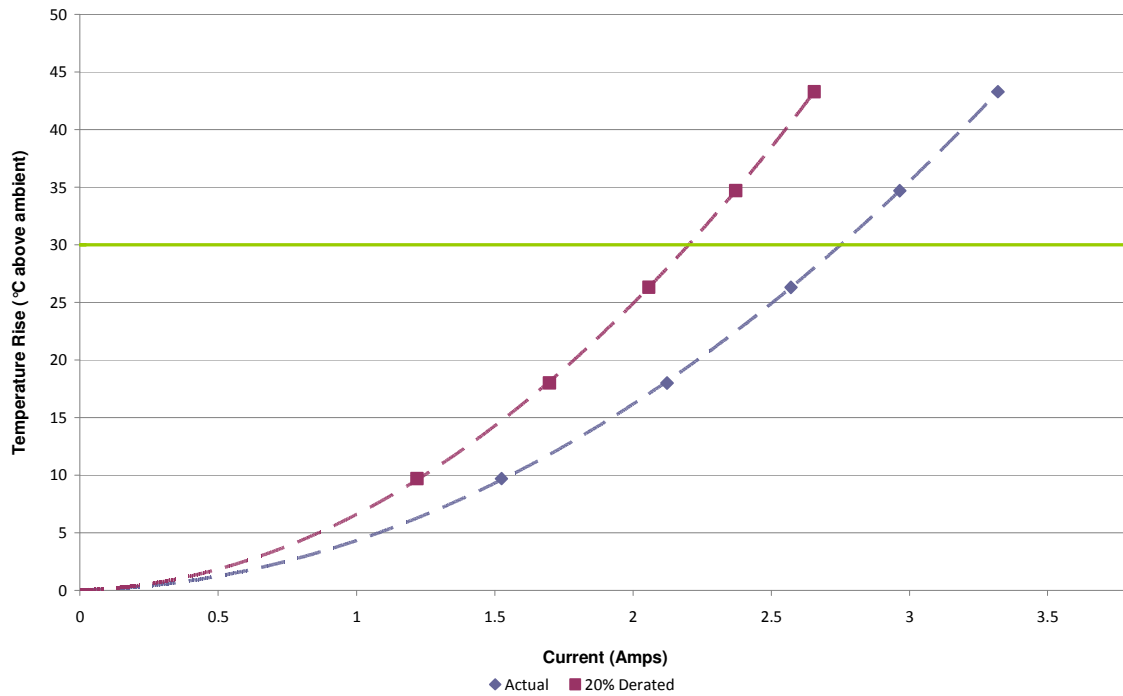



**POWER INTEGRITY TEST
REPORT**

277286
INITIAL RELEASE

**TEMPERATURE RISE DATA
FOUR CONTACTS ENERGIZED
(Degrees Celsius above ambient)**

TEST CURRENT AMPS	1.52	2.12	2.57	2.97	3.32
Sample 4	10.3	18	26.5	35.1	43.6
Sample 5	9.3	17.9	26	34.4	43
Sample 6	9.5	18.2	26.4	34.6	43.2
Min	9.3	17.9	26	34.4	43
Max	10.3	18.2	26.5	35.1	43.6
Avg	9.7	18.03	26.3	34.7	43.27

✦ Indicates energized contacts

✦ Indicates thermocouple monitored, energized contacts

✦	✦		
✦	✦		

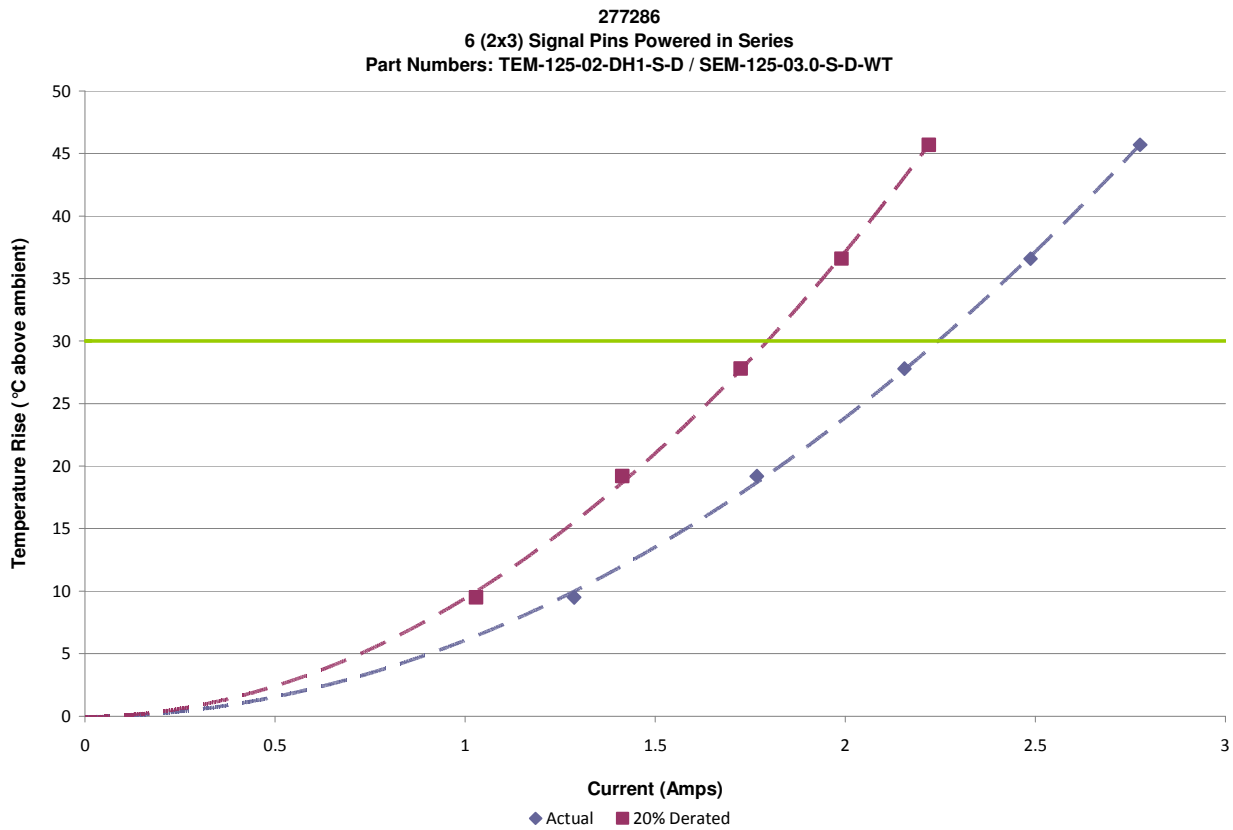
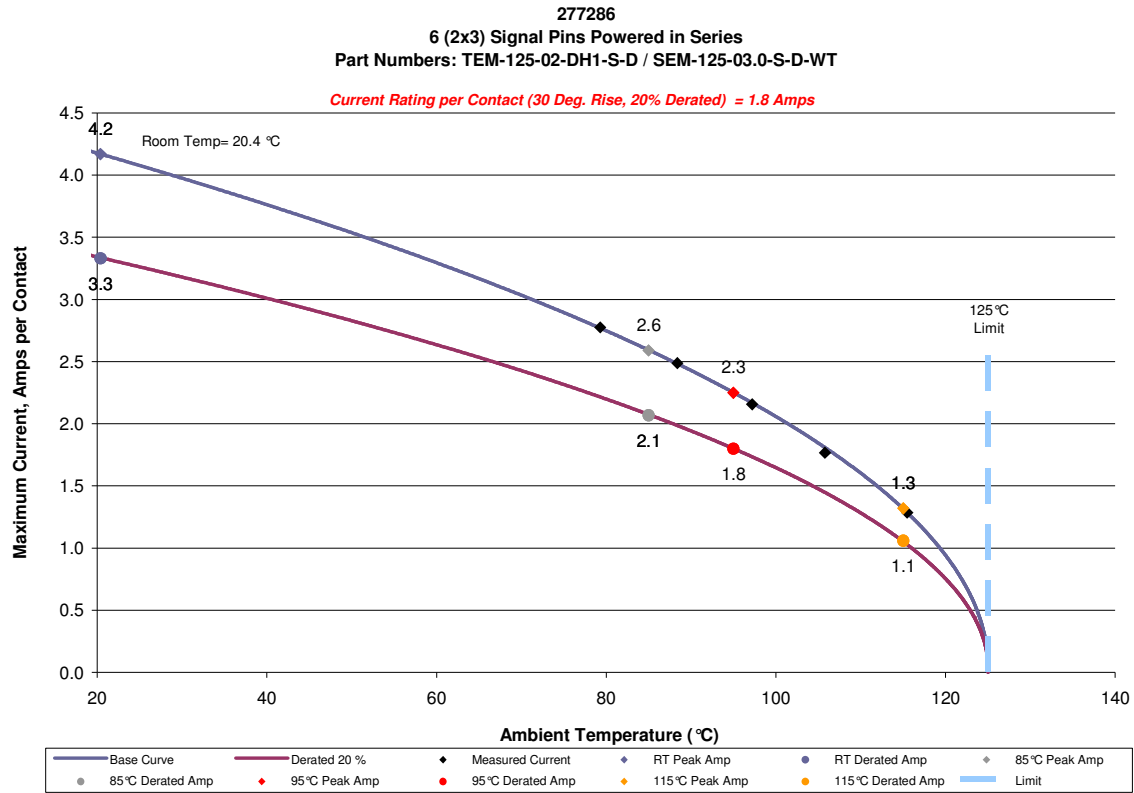



**POWER INTEGRITY TEST
REPORT**

277286
INITIAL RELEASE

**TEMPERATURE RISE DATA
SIX CONTACTS ENERGIZED
(Degrees Celsius above ambient)**

TEST CURRENT AMPS	1.29	1.77	2.16	2.49	2.78
Sample 7	8.4	19.8	27.7	36.4	45.4
Sample 8	9.9	18.5	27.3	36	45
Sample 9	10.1	19.3	28.3	37.3	46.6
Min	8.4	18.5	27.3	36	45
Max	10.1	19.8	28.3	37.3	46.6
Avg	9.47	19.2	27.77	36.57	45.67

- ✦ Indicates energized contacts
- ✦ Indicates thermocouple monitored, energized contacts

✦	✦	✦	
✦	✦	✦	

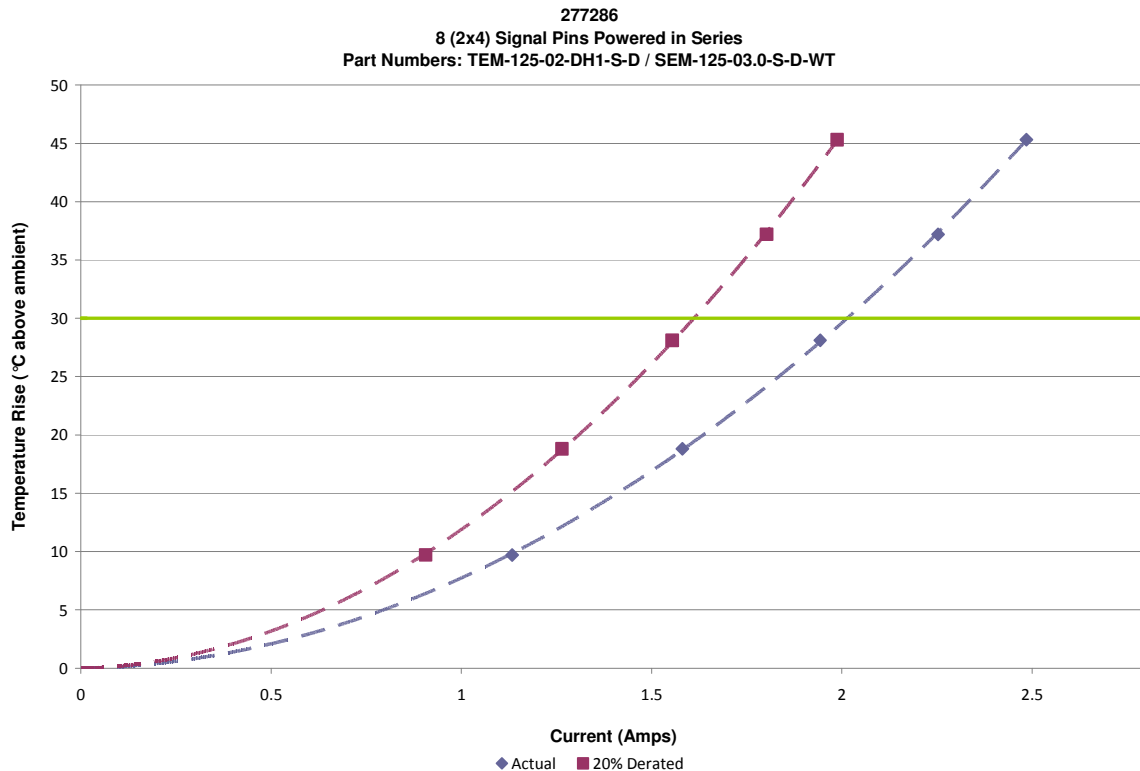
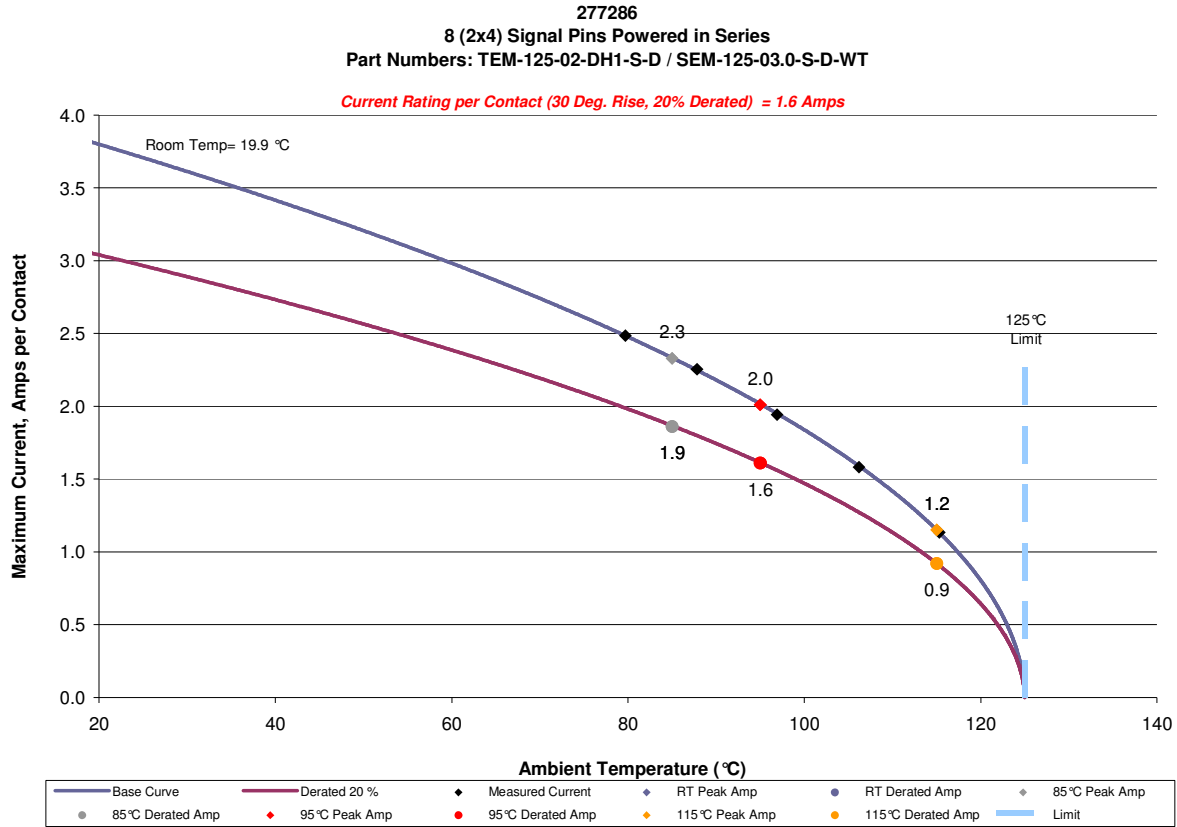



POWER INTEGRITY TEST REPORT

277286

INITIAL RELEASE

TEMPERATURE RISE DATA EIGHT CONTACTS ENERGIZED (Degrees Celsius above ambient)

TEST CURRENT AMPS	1.13	1.58	1.94	2.25	2.49
Sample 10	9.8	18.9	28.2	37.3	45.3
Sample 11	9.7	18.7	27.9	37	45.1
Sample 12	9.7	18.8	28.1	37.4	45.5
Min	9.7	18.7	27.9	37	45.1
Max	9.8	18.9	28.2	37.4	45.5
Avg	9.73	18.8	28.07	37.23	45.3

✦ Indicates energized contacts

✦ Indicates thermocouple monitored, energized contacts

✦	✦	✦	✦
✦	✦	✦	✦

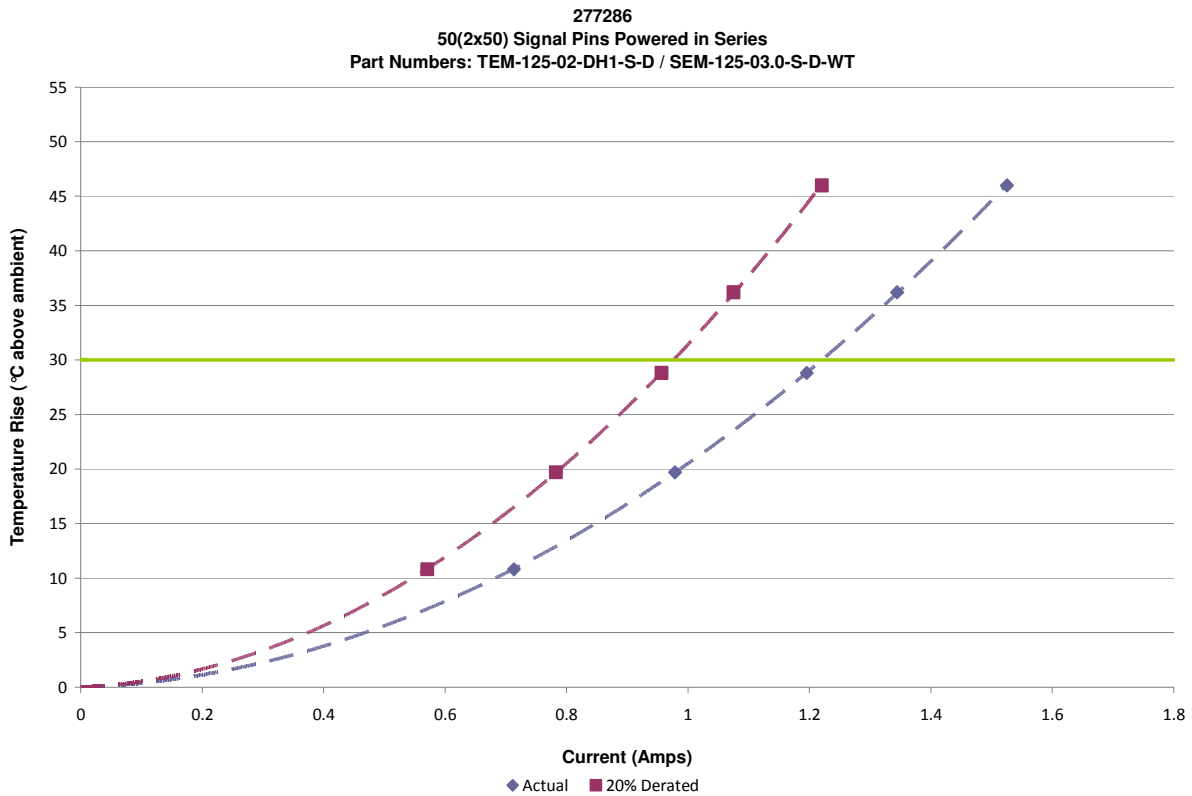
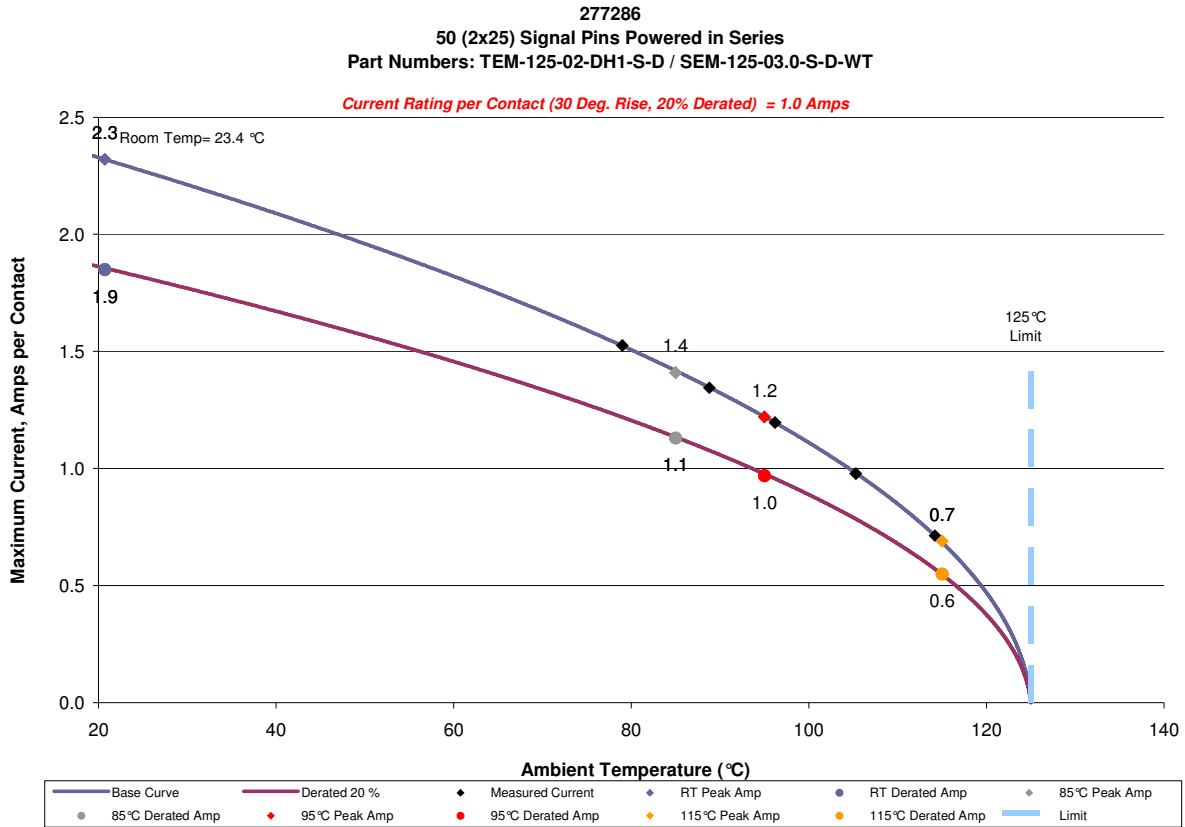

**TEMPERATURE RISE DATA
ALL CONTACTS ENERGIZED
(Degrees Celsius above ambient)**

TEST CURRENT AMPS	0.71	0.98	1.2	1.34	1.53
Sample 25	11.4	20	29.2	36.6	46.1
Sample 26	10.6	20	29.2	36.8	47
Sample 27	10.3	19.2	28.1	35.3	44.8
Min	10.3	19.2	28.1	35.3	44.8
Max	11.4	20	29.2	36.8	47
Avg	10.77	19.73	28.83	36.23	45.97

- ✦ Indicates energized contacts
- ✦ Indicates thermocouple monitored, energized contacts

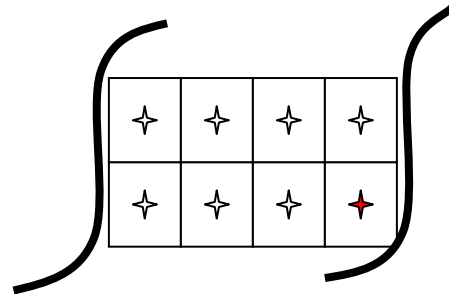

CURRENT CYCLING VS. TEMPERATURE RISE

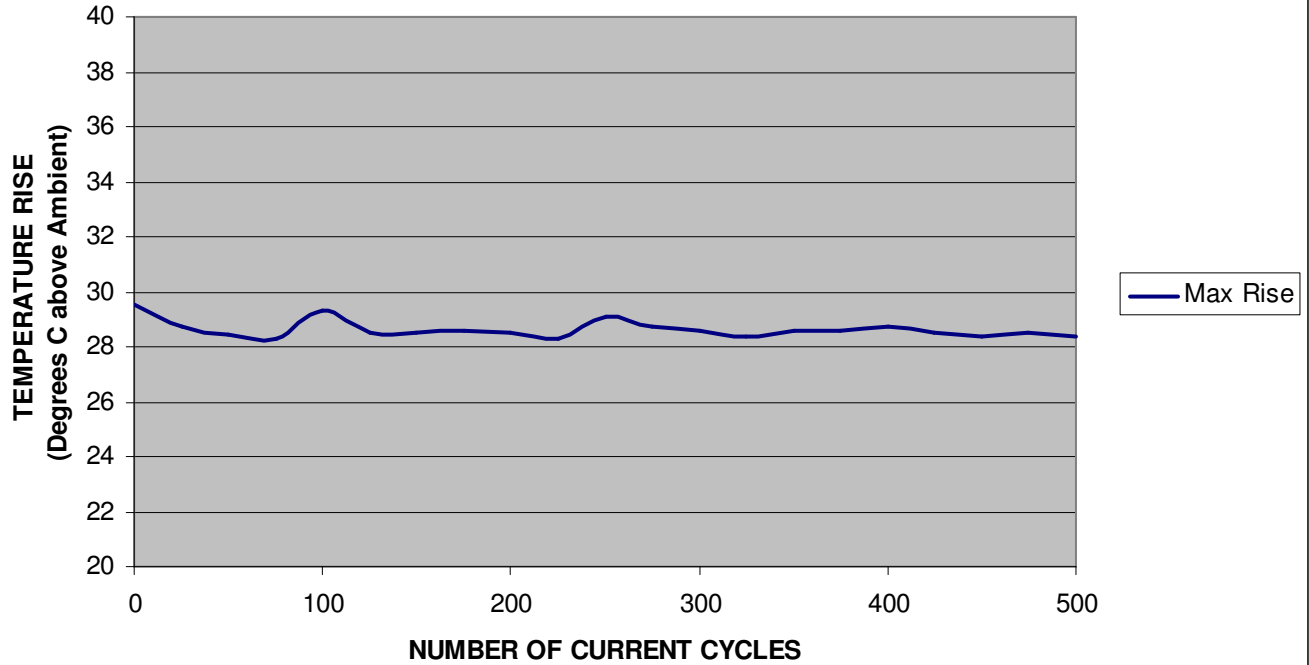

**TEMPERATURE RISE DATA
ALL CONTACTS ENERGIZED
(Degrees Celsius above ambient)**

	INITIAL	50 CYCLES	100 CYCLES	200 CYCLES	500 CYCLES
Min	27.4	27.5	27.4	27.3	27.5
Max	29.5	28.4	29.3	28.5	28.4
Avg	28.6	27.8	28.1	27.8	27.9

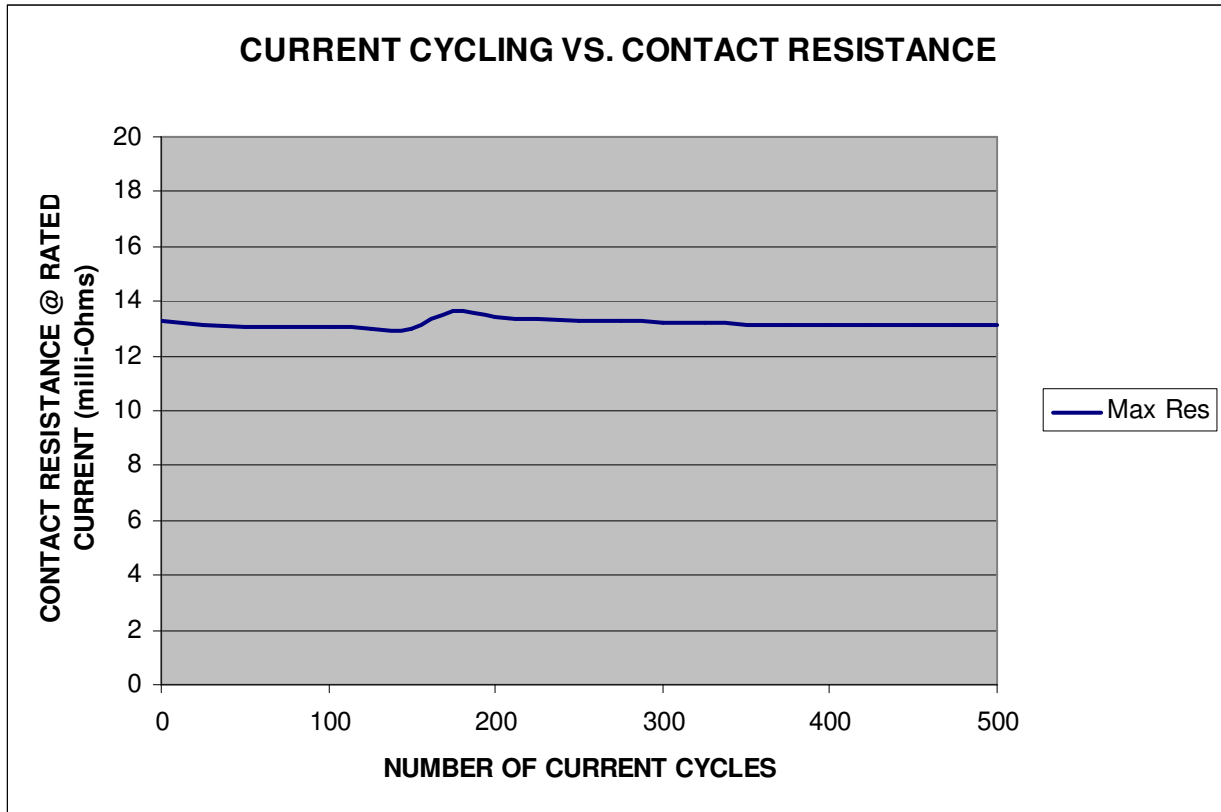

**CONTACT RESISTANCE DATA
ALL CONTACTS ENERGIZED
(mΩ)**

	INITIAL	50 CYCLES	100 CYCLES	200 CYCLES	500 CYCLES
Min	7.59	7.45	7.44	7.53	7.49
Max	13.28	13.09	13.03	13.41	13.12
Avg	9.45	9.02	8.92	8.86	8.85

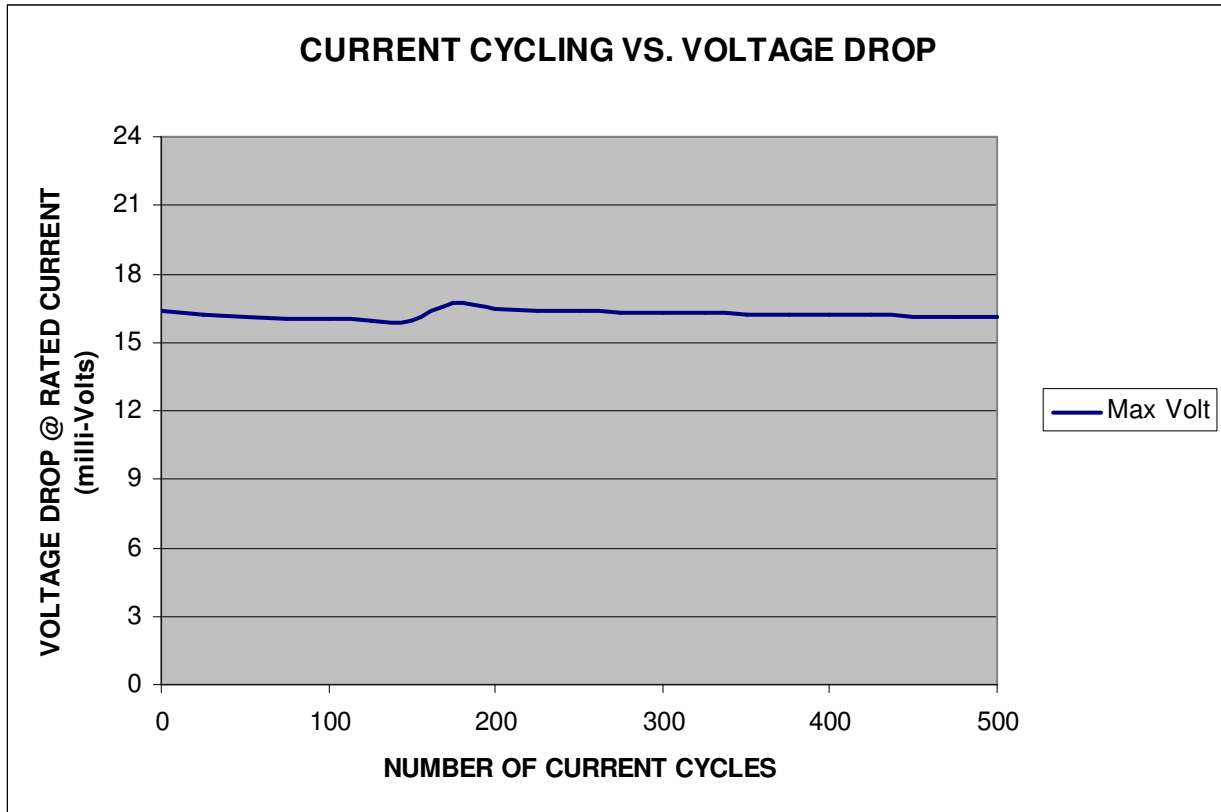

**VOLTAGE DROP DATA
ALL CONTACTS ENERGIZED
(MV)**

	INITIAL	50 CYCLES	100 CYCLES	200 CYCLES	500 CYCLES
Min	9.33	9.16	9.15	9.26	9.21
Max	16.34	16.1	16.03	16.5	16.14
Avg	11.62	11.1	10.98	10.89	10.89



**POWER INTEGRITY TEST
REPORT**

277286

INITIAL RELEASE

EQUIPMENT AND CALIBRATION SCHEDULES

Equipment #: HZ-MO-01

Description: Multimeter /Data Acquisition System

Manufacturer: Keithley

Model: 2700

Serial #: 1199807

Accuracy: See Manual

... Last Cal: 06/01/2013, Next Cal: 05/31/2014

Equipment #: HZ-PS-01

Description: 20 V, 120 A DC Power Supply - AutoRanging SO/HPIB

Manufacturer: Hewlett Packard / Agilent

Model: AT-6031A

Serial #: 2721A00648

Accuracy: See Manual

... Last Cal: Reference Only, Next Cal: Reference Only

Equipment #: HZ-MO-06

Description: Model 2750 Multimeter/Switch System

Manufacturer: Keithley

Model: 2750

Serial #: 13107320

Accuracy: See Manual

... Last Cal: 01/30/2013, Next Cal: 01/29/2014

Equipment #: HZ-PS-03

Description: 60 V, 30 A DC Power Supply - AutoRanging SO

Manufacturer: Hewlett Packard / Agilent

Model: AT-6033A

Serial #: 3329A-07330

Accuracy: See Manual

... Last Cal: Reference Only, Next Cal: Reference Only